

SUBJECT: Wear Of The Temperate, Hot-Weather, and Enhanced Hot-Weather Battle Dress Uniforms (BDU) for Soldiers of the Texas State Guard

1. Authorization for wear the temperate, hot weather (HW), and enhanced hot weather (EHW) battle dress uniforms (BDUs) are authorized for year-round wear by all personnel when prescribed by the commander (See Figure 1).

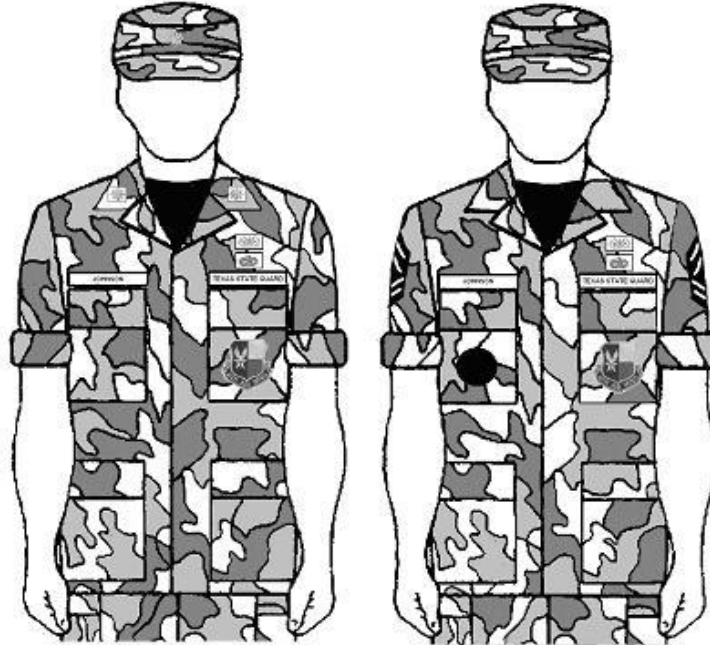

Figure 1. Temperate and hot-weather battle dress uniform, with beret and patrol cap, sleeves rolled

2. Material composition.

a. Enhanced hot-weather coat and trousers. Fabric is 50/50 ripstop nylon and cotton poplin, in a four-color woodland camouflage pattern.

b. Hot-weather coat and trousers. Fabric is 100 percent ripstop cotton, in a four-color woodland camouflage pattern.

c. Temperate coat and trousers. Fabric is 50/50 nylon and cotton twill, in a four-color woodland camouflage pattern.

3. Occasions for wear,

a. Texas Medical Rangers may wear BDUs on duty when prescribed by the commander. Texas Medical Rangers may wear BDUs off post unless prohibited by the commander. They may not wear BDUs for commercial travel. Personnel may not wear BDUs in establishments that primarily sell alcohol. If the establishment sells alcohol and food, Texas Medical Rangers may not wear utility uniforms if their activities in the establishment center on drinking alcohol only.

b. Utility uniforms are not normally considered appropriate for social or official functions off the installation, such as memorial services and funerals. These uniforms are issued as utility, field, training, or combat uniforms and are not intended for wear as all-purpose uniforms when other uniforms are more appropriate.

4. General guidelines.

a. These uniforms are designed to fit loosely; alterations to make them fit tightly are not authorized. A tight fit reduces the airflow needed for ventilation and cooling. Personnel are authorized to mix and match hot-weather and enhanced hot-weather coats, trousers, and patrol caps. However, personnel may not mix hot weather and temperate uniform items, to include the patrol cap.

b. The coat is worn outside the trousers, and the trousers are worn with a belt. The coat will not extend below the top of the cargo pocket on the pants and will not be higher than the bottom of the side pocket on the pants. Commanders may authorize exceptions to this policy under conditions deemed appropriate in the interest of health because of climatic conditions; or to accommodate a Texas Medical Ranger's religious practice.

c. Texas Medical Rangers will wear the trousers bloused, using the draw cords or blousing rubbers, if the trousers are not tucked into the boots. Personnel will not wrap the trouser leg around the leg tightly enough to present a pegged appearance; Texas Medical Rangers will not blouse the boots so that the trouser leg extends down to the ankle area. When bloused, the trousers should not extend below the third eyelet from the top of the boot. When Texas Medical Rangers wear the sleeves of the coat rolled up, the camouflage pattern will remain exposed. Personnel will roll the sleeves neatly above the elbow, no more than 3 inches above the elbow.

d. The commander may require that Texas Medical Rangers press these uniforms for special occasions when an especially sharp appearance is required, such as parades, reviews, inspections, or other ceremonial occasions. Although Texas

Medical Rangers are authorized to starch the BDU, commanders may not require them to do so. Texas Medical Rangers are authorized to press military creases in the BDU coat.

e. When uniformity in appearance is required, commanders may prescribe a specific uniform for formations or ceremonial occasions, such as parades. When a specific uniform is not prescribed, Texas Medical Rangers may wear the enhanced hot weather, or temperate BDU, or other authorized utility uniforms.

f. Texas Medical Rangers may wear the black leather shell gloves with utility uniforms without cold-weather outer garments, provided that sleeves are rolled down. Personnel may wear the woodland camouflage cold-weather coat with all utility uniforms. Texas Medical Rangers may wear the Black all-weather coat as a raincoat with these uniforms only in a garrison environment when they have not been issued organizational raingear. When the cold-weather coat or other authorized cold weather outer garments are worn, personnel may wear the olive-green scarf and the black leather shell gloves, but are not required to do so. Coats are worn buttoned and zipped, and the shirt collar is worn inside the cold-weather coat and other outer garments. Texas Medical Rangers may wear the hood of the cold-weather coat at their option. However, when the hood is not worn, Texas Medical Rangers will tuck it into the jacket and will zip the zipper. Female personnel may carry handbags with these uniforms only while in a garrison environment.

g. Commanders may authorize the use of a camouflage personal hydration system only in the following situations: in a field environment, in high-heat areas, or on work details. Texas Medical Rangers will not carry hydration systems in a garrison environment unless the commander has authorized it for one of the situations described above. Texas Medical Rangers will not let the drinking tube hang from their mouths when the device is not in use.

4. Uniform composition.

a. Coat, woodland camouflage pattern. The coat is a single-breasted "bush type" design with a collar and four patch bellows-type pockets with flaps (two chest and two lower). The coat has a straight-cut bottom, waist take-up tabs on both sides (old version only), and cuffed sleeves with reinforcement patches at the elbows. The enhanced hot weather coat has a fused collar and pocket flaps, a suppressed waist (3 inches), and no waist adjustment tabs.

b. Trousers, woodland camouflage pattern. The trousers have four standard type pockets and two leg bellows-type pockets, and

reinforcement patches at the knees and buttocks. The trousers have a buttonhole fly with protective flap (hot-weather battle dress uniform: (HWBDU)), adjustable waist tabs (old version only), and leg-hem draw cords. The HWBDU trousers with knee pleats are authorized for wear until current stocks are exhausted. The knee pleats were removed from the enhanced hot-weather battle dress uniform (EHWBDU) trousers.

d. Belt, web waist, Black tip.

1) Description: The belt is blue cotton web or blue woven elastic, with a Black tip, and is 11.4 inches wide.

a) The Black tip belt is worn with the Black, open-faced buckle. It is worn so that the tipped end passes through the buckle to the wearer's left; the tipped end will not extend more than 2 inches beyond the edge of the buckle. The plain end of the belt may extend beyond the keeper portion of the inside of the buckle, as long as it is not visible when worn.

b) All personnel will wear the Black tip belt and black, open-faced buckle with utility uniforms that have belt loops.

e. Buckle, belt, black, open-faced.

1) Description. A black, open-faced brass buckle, 1-11/16 inches long and 1.58 inches wide (See Figure 2).

2) How worn. The buckle is attached to the end of the blue web belt with the black tip, and is worn only with utility uniforms.

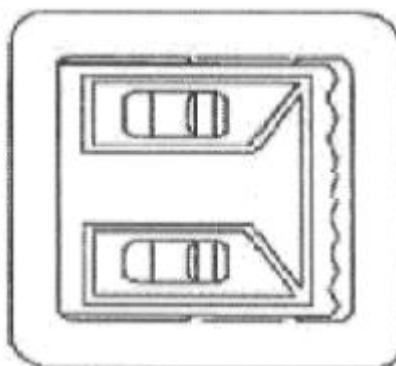

Figure 2. Black buckle

f. Boots, combat, leather black. See Appendix B, wear of black combat boots.

g. Insignia, distinguishing, Texas State Guard

1) Description. For woodland camouflage uniforms, the insignia is a woven tape of olive-green cloth, 1 inch wide, with the inscription "TEXAS STATE GUARD" in blue block letters, 3/4 inch high. The length of the Texas State Guard distinguishing insignia tape is 4 1/2 inches, or it extends to the edge of the pocket flap when sewn on the uniform (See Figure 3).



Figure 3. Insignia, distinguishing, Texas States Guard tape

2) How worn. The Texas State Guard distinguishing insignia tape is worn immediately above, and parallel to the top edge of the left breast pocket of the uniform shirt, only. Personnel are not authorized to have the words U.S. Army embroidered directly on the uniform (See Figure 4).

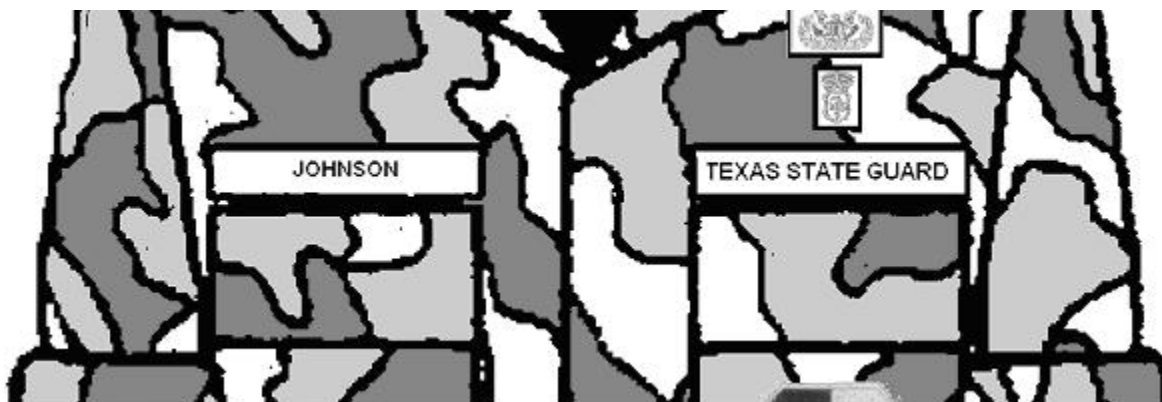

Figure 4. Wear of nametape and Texas State Guard distinguishing tape

h. Insignia, nametape.

1) Description. For woodland camouflage uniforms, the nametape is a strip of olive-green cloth, 1 inch wide, with the individual's last name in blue block letters, 3/4 inch in height. Last names consisting of 11 letters or more are constructed using Franklin Gothic extra-condensed print (48 point) 1/2 inch high (see Figure 5). The nametape insignia is 4

1/2 inches in length, or extends to the edge of the pocket flap when sewn on the uniform.



Figure 5. Insignia, Name Tape

2) How worn. All personnel will wear the nametape above the top right breast pocket on the same uniforms and in the same manner as described for the "U. S. AIR FORCE" tape. When the nametape is worn with the U.S. Army tape, both must be the same size, 4 1/2 inches in length, or they must extend to the edge of the pocket flaps, Personnel are not authorized to have the last name embroidered directly onto the uniform (See Figure 4).

i. Pocket sleeve insignia, subdued, Texas Medical Rangers.

1) Description. See Figure 6.



**Figure 6. Subdued Pocket Patch
4th Air Wing, Texas State Guard**

2) How worn. All personnel wear the subdued unit insignia on the temperate, hot-weather, enhanced hot-weather BDU; and the BDU field jacket. All personnel will wear the subdued unit patch of the 4th Air Wing centered on the left pocket below the pocket flap (See Figure 7).

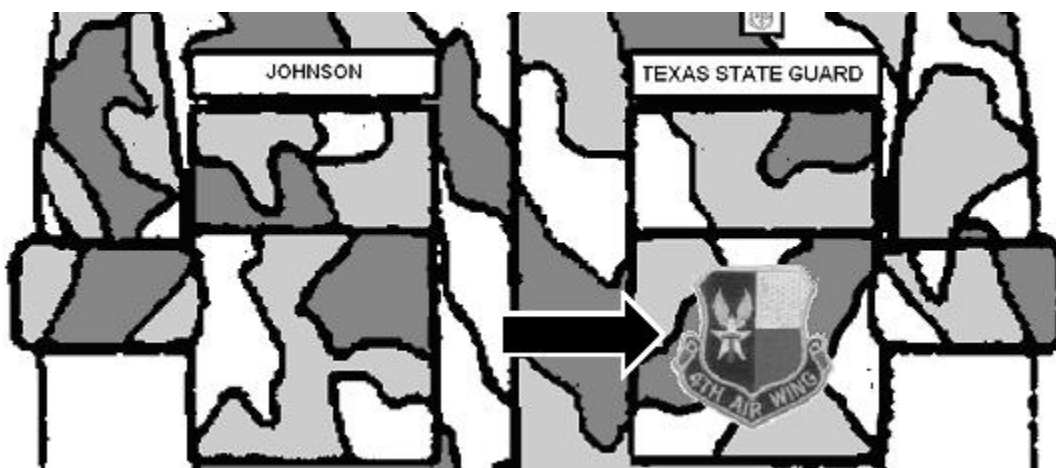

Figure 7. Wear of AF Style Patch

j. Insignia, Former Wartime service, subdued.

1) General. Not to be worn on Air Force style BDUs.

k. Insignia of Grade, subdued.

1) Officers other than General Officers, subdued.

a) Officers wear subdued grade insignia on all temperate, hot weather, enhanced hot-weather, and desert BDU, and the BDU field jacket utility uniforms.

b) On all temperate, hot weather, enhanced hot-weather, and desert BDU, and the BDU field jacket the subdued insignia is worn centered horizontally on the each collar, 1 inch from the lower edge of the collar, with the centerline of the insignia parallel to the lower edge of the collar (See Figure 8). Personnel may only sew-on, embroidered or woven, subdued grade insignia on the BDU uniform blouse. Bright metal rank insignia are worn on the BDU patrol cap.

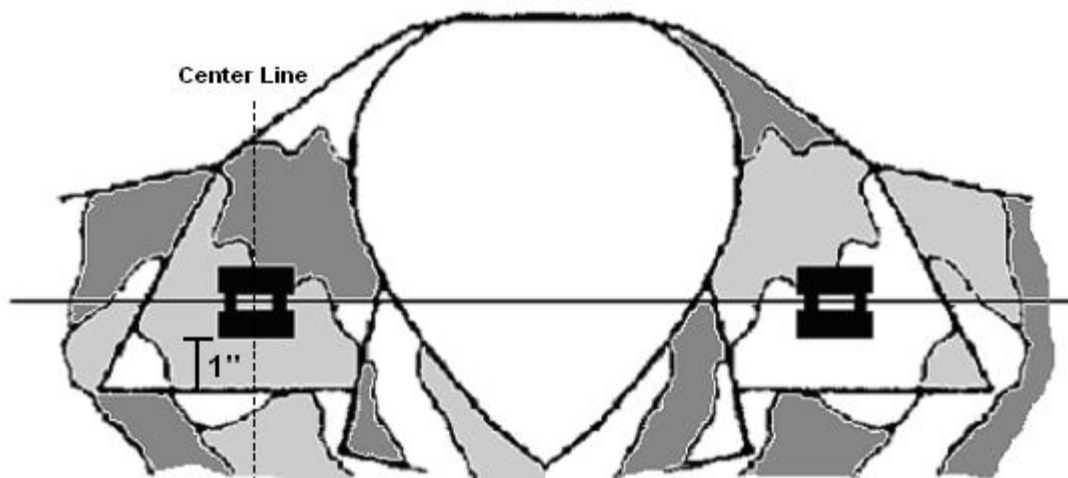

Figure 8. Insignia of grade, subdued, officers other than GO's, on BDU shirt collar

2) Enlisted, subdued.

a) All enlisted personnel will wear subdued grade insignia on sleeve of BDU's. The subdued insignia of grade is worn on each sleeve centered between the top of shoulder and elbow break. See Figure 9.

b) There is no pin-on rank for the enlisted BDU

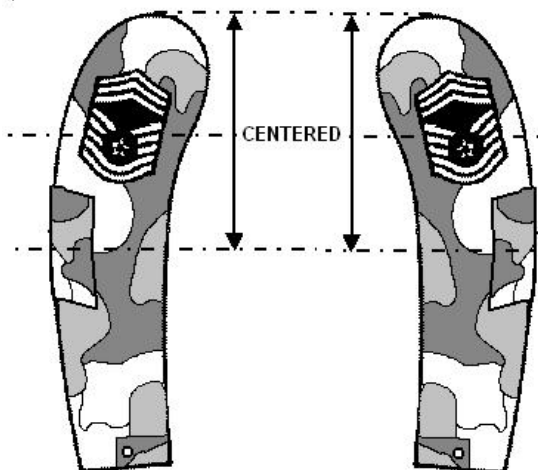

Figure 8. Insignia of grade, subdued, enlisted

1. Branch Insignia, subdued.

1) On all BDU uniforms, male and female officers may wear (optional) subdued AFSC insignia centered above the left breast pocket, above the TEXAS STATE GUARD name tape (See Figure 10).

2) No more than two AFSC specialty badges may be worn.

3) Officers and enlisted members may both wear approved insignia. Embroidered patches only.

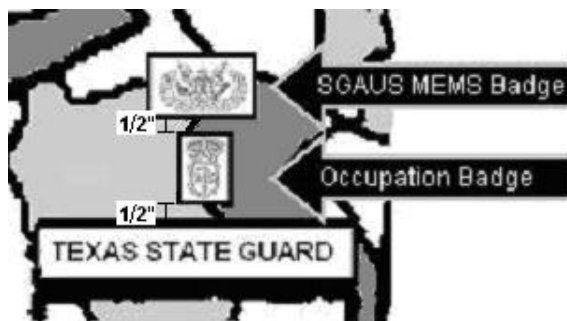

Figure 10. Wear of insignia of branch on the officer duty uniform

m. Subdued pin-on and embroidered sew-on combat and special skill badges. Personnel may wear no more than five subdued combat and special skill badges on the BDU. Badges are worn one above the other, centered above the U.S. Army tape, in order of group precedence. When five badges are worn, three are centered 1/4 inch above the U.S. Army tape in a vertical line with 1/2 inch between badges, and two are worn on the pocket flap, 118 inch below the top of the pocket, with at least 1 inch between badges. When four badges are worn, three are centered 114 inch above the U.S. Army tape in a vertical line with 1/2 inch between badges, and one is worn on the pocket flap, 1/8 inch below the top of the pocket, with at least 1 inch between badges. When three badges are worn, two badges are centered 1/4 inch above the U.S. Army tape in a vertical line with 1/2 inch between badges, and one is worn centered on the pocket flap, 118 inch below the top of the pocket, When two badges are worn, both are centered 1/4 inch above the U.S. Army tape in a vertical line with 1/2 inch between badges. If only one badge is worn, it is centered 11.4 inch above the U.S. Army tape (See Figure 11).



Figure 11. Wear of subdued combat and special skill badges

n. Subdued Identification Badges.

1) Order of Precedence of U. S. Military Identification (ID) Badges authorized for wear on the Army uniform: Presidential Service identification badge; Vice-presidential Service identification badge; Secretary of Defense identification badge; Joint Chiefs of Staff identification badge; Army Staff identification badge; Guard, Tomb of the Unknown Texas Medical Ranger identification badge; Drill Sergeant identification badge; U.S. Army Recruiter identification badge, Active Army and Army Reserve; Army Career Counselor identification badge; Army National Guard Recruiting and Retention identification badge, Master; and Secretary of Health and Human Services identification badge,

2) How worn.

a) Personnel may wear no more than two identification badges on one pocket or side of the coat of the uniform. When two identification badges are worn on the same side or pocket, the precedence of the badges is from the wearer's right to left. When more than two badges are awarded that are worn on the same side, the individual may determine which two badges are worn on the uniform.

b) Subdued badges are worn on the BDU shirts with the badge centered on the appropriate breast pocket between the bottom of the pocket flap and the bottom of the pocket, or in a similar location on uniforms without pockets. When two badges are worn on the same side, they are spaced equally from left to right on the pocket.

o. Foreign badges are not authorized for wear on the BDU shirt.

p. Socks, Black, cushion sole.

1) Description. The socks are black nylon and wool blend, stretch type, calf-length with a cushion sole.

2) How worn. The Black, cushion sole socks are worn by all personnel when wearing combat or organizationally issued boots. They can also be worn as a two-sock system with the standard liner sock (also called the Black dress sock) for additional foot protection.

q. Undergarments.

1) Brassieres and underpants.

a. Description. Brassieres and underpants may be of a commercial design, in white, Black, or other neutral colors that are not readily apparent when worn under the uniform. The category of brassieres also includes sports bras.

b. How worn. Females will wear brassieres and underpants with all uniforms.

2) Camisoles

a) Description, The camisole is of a commercial design in white, Black, or other neutral colors not readily apparent under the uniform.

b) How worn. Females are authorized to wear the camisole with all uniforms. The camisole is not a substitute for the brown undershirt when the brown undershirt is normally part of the uniform (such as the BDU, flight uniform, cold-weather uniform, and so forth). The camisole is not a substitute for brassieres. Females will ensure that uniforms fit properly when wearing the camisole.

3) Drawers.

a) Description. The drawers are brown, in brief length.

b) How worn. All males will wear drawers with all uniforms. Either the brief or boxer style drawers are authorized for wear. Males also may wear commercially purchased brief or boxer versions of drawers, in white, brown, or other neutral colors

4) Undershirt, brown, AG shade 436.

a) Description. The material is cotton knitted cloth, with quarter-length sleeves and a crew neck, or is of a similar commercial design.

b) How worn. All personnel will wear the undershirt with all utility uniforms, except for hospital duty and food service uniforms.

c) Personnel are not authorized to wear the white undershirt with the BDU, flight uniforms, combat vehicle crewman uniforms, or other utility or field uniforms that require wear of the brown undershirt.

r. Coat, Blue, All-Weather.

s. Gloves, Black leather shell with inserts.

1) Description. The gloves are a five-finger design in a slip-on style. An adjustable strap and buckle is provided on the back of the gloves. The inserts are Black wool and are worn inside the Black leather shell gloves. There is no wear out date for the green wool inserts, which may be worn until stocks are exhausted or until unserviceable

2) How worn. These gloves are authorized for wear with or without cold weather outer garments. Texas Medical Rangers may wear the Black leather shell gloves with utility uniforms without cold-weather outer garments, provided sleeves are rolled down. Personnel may not wear the inserts without the leather shell gloves when worn with utility uniforms and cold weather outer garments.

t. Handbags.

1) Handbag, clutch-type, leather, polyurethane, or vinyl.

a) Description. The handbag is Black and is made of leather, polyurethane, or vinyl, in a commercial design with a zipper, snap, or envelope-type closure. The handbag may have a wrist strap, but not a shoulder strap.

b) How worn. Females may carry the clutch-type handbag with the female service uniforms, and with the utility uniforms while in a garrison (non-field) environment. The leather version of this handbag is authorized for use with the female Air Force black uniform, during and after duty hours.

2) Handbag, shoulder, Black.

a) Description. The handbag is a commercial design, Black, in polyurethane or leather, with a shoulder strap attached.

b) How worn. Females may carry this handbag with the service and Air Force black uniforms, and with utility uniforms while in a garrison (non field) environment. Females may carry the bag in the hand or wear it over one shoulder. Texas Medical Rangers may not wear the shoulder bag in such a manner that the strap is draped diagonally across the body, with the purse resting on the hip opposite the shoulder holding the strap.

u. Scarves, Black and Olive-Green 208. See Information Paper on Wear Of Scarves.

5. Point of Contact is CSM Knobel at (210) 724-4565,